

YN360 摄像灯 Pro LED Video Light 使用说明书

在使用产品前,请认真阅读说明书并妥善保管以便将来查阅
总述

首先感谢您使用永诺YN360摄像灯,YN360是我司首款由RGB贴片灯与LED灯珠相结合的摄像灯。它由40颗RGB贴片灯和160颗3200K色温的灯珠和160颗5500K色温的灯珠构成。RGB贴片灯可以提供红色、绿色、蓝色模式,通过手机APP的彩色模式控制RGB贴片灯颜色,颜色种类更加丰富。YN360可以在3200K至5500K之间任意调节所需的色温;采用永诺专有LED驱动技术和编码器数字调光模式,调光精准、可靠;手机无线遥控摄像灯的亮度等强大功能。具有操作简单、实用性强、颜色多样化等优点。

一、产品结构

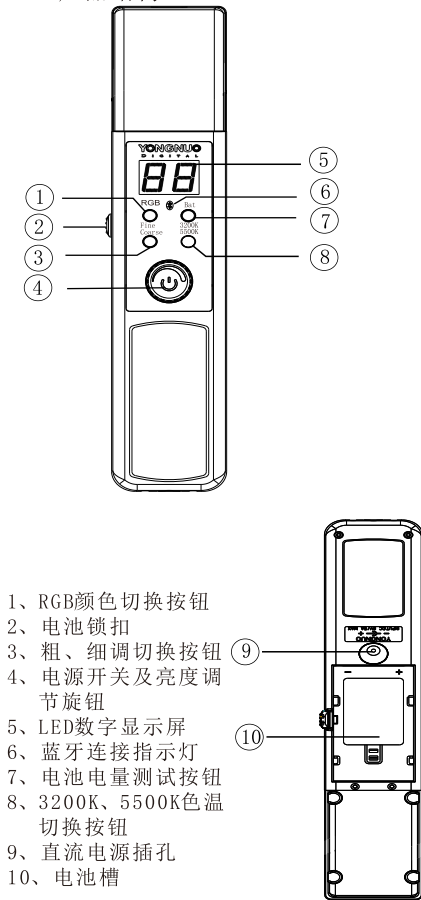

- 1、RGB颜色切换按钮
- 2、电池锁扣
- 3、粗、细调切换按钮
- 4、电源开关及亮度调节旋钮
- 5、LED数字显示屏
- 6、蓝牙连接指示灯
- 7、电池电量测试按钮
- 8、3200K、5500K色温切换按钮
- 9、直流电源插孔
- 10、电池槽

二、功能简介

- 1、行业首款RGB全彩摄像灯,让您的创作更具特色。
- 2、主灯光采用160颗3200K色温和160颗5500K色温超大芯片、超高显指的灯珠,色彩还原真实自然。
- 3、采用永诺专有LED驱动技术,拍摄时绝不出现波纹、频闪等现象。
- 4、采用编码器数字调光,可分粗调、细调模式,使用更方便。
- 5、采用LED数字显示屏,功率输出更直观。
- 6、支持外接直流电源输入,方便您长时间拍摄使用(电源适配器为选配)
- 7、色温板采用磁铁吸合技术使用更方便。

三、使用方法

1、安装电池

- a、安装锂电池时按箭头方向将电池装入卡槽。
注:建议使用永诺NP-F750电池来获得更持久的拍摄体验,此电池容量高达5200mAh在最高亮度下可持续使用约120分钟,不使用时请取下电池。

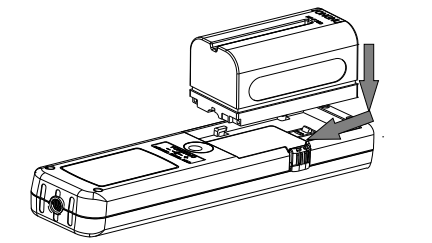

- b、拆卸锂电池时,请先按下电池锁扣再取出锂电池

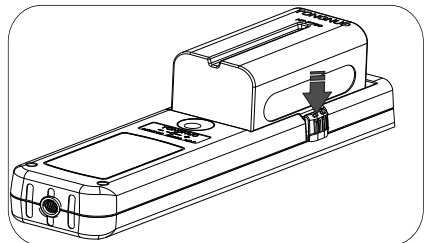

- 2、根据您的需要可以通过以下方式固定摄像灯:
直接固定在三脚架上使用

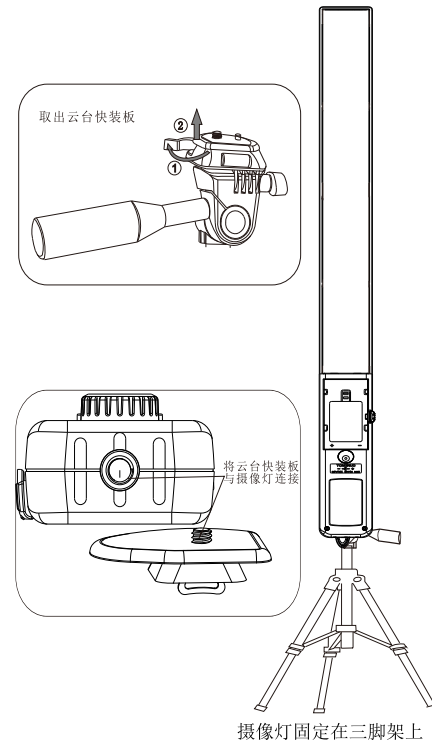

摄像灯固定在三脚架上

3、开关机及亮度调节

按电源开关,LED摄像灯点亮。向右旋转增加亮度,向左旋转减小亮度。

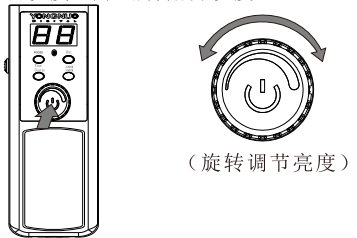

(旋转调节亮度)

4、RGB颜色切换按钮

按下按钮红灯亮时,可调节红灯亮度;绿灯亮时,可调节绿灯亮度;蓝灯亮时,可调节蓝灯亮度。可通过改变三种颜色的亮度比例获得各种颜色。
注:RGB颜色模式与3200K、5500K色温模式是不能同时使用的。

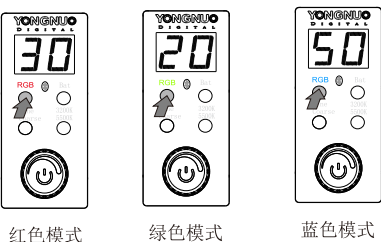

红色模式 绿色模式 蓝色模式

5、粗、细调节方式切换

可分粗调、细调模式,使用更方便。按下粗/细调切换按钮进行亮度粗细调的切换,当Coarse的指示灯亮起则进入粗调模式,亮度按10%为一个调节单位,再按下此按钮,Fine的指示灯亮起则进入细调模式,亮度按1%为一个调节单位。

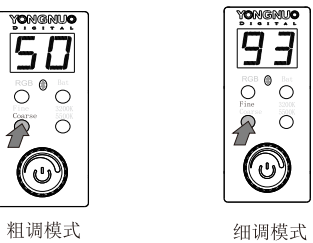

粗调模式 细调模式

6、电量测试按钮

按下电量测试按钮进行电量测试,当Bat的功能指示灯亮起LED显示屏所显示的读数则为电池电量。电量的读数可分为P0-P9分别就是0%-90%,如图电池的电量30%。(注:低亮度时测试与高亮度时测试剩余电量是不相同的,测的是当前亮度下,可以使用时间的长短)。

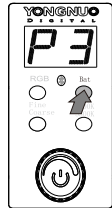

数码管显示电池的电量

7、3200K、5500K色温切换按钮

通过改变两者之间的亮度比例得到3200K至5500K之间的色温。注:3200K、5500K色温模式与RGB颜色模式不能同时使用。

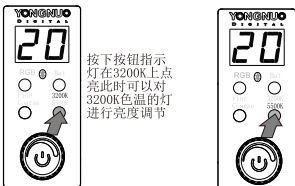

按下按钮指示灯在3200K上点亮此时可以对3200K色温的灯进行亮度调节

按下按钮指示灯在5500K上点亮此时可以对5500K色温的灯进行亮度调节

8、外接电源供电

可选配永诺电源适配器,以获得摄像灯的长时间工作。当使用外接电源时,摄像灯将自动切断电池供电且不对电池充电。电源接口为内正外负,输入电压为8伏,电流为5安。
注:如使用其他电源适配器造成的产品故障,不予保修。

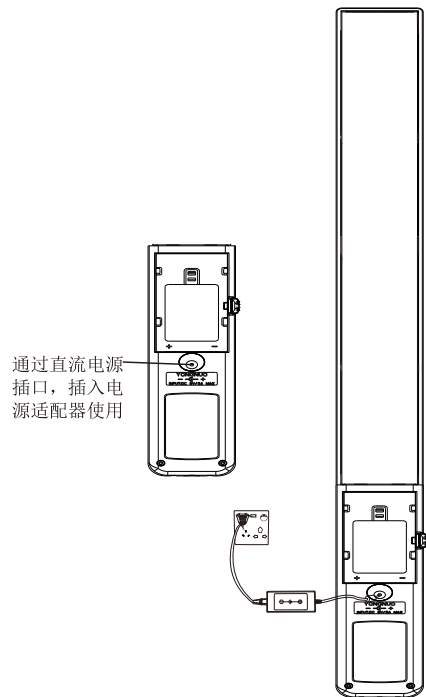

通过直流电源插口,插入电源适配器使用

四、更换色温板

本产品附带1块色温板,从产品背后取出色温片,将色温片放在摄影灯面壳前被磁铁吸住即可使用。

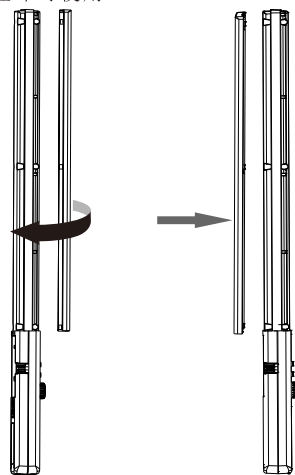

五、产品规格

光源	320颗LED灯珠与40颗RGB贴片灯		
色温	3200K、5500K和RGB全彩		
显色指数	大于或等于95	遥控距离	小于15米
输出功率	19.2瓦	手机遥控	蓝牙4.0
流明值	2480LM	平均寿命	50000小时
重量	489克	光照角度	55°和110°
适用电池	1个NP-F系列锂电池		
外接电源	8伏5安直流电源		
体积	583*48*24毫米		
所含物品:摄像灯(1)、说明书(1)、色温板(1)、收纳袋(1)注:如有缺失请与经销商联系			

六、手机APP遥控

本产品支持手机遥控(支持Android 4.3及以上搭载蓝牙4.0的智能手机/iOS7.0且iPhone4S以上版本的手机),APP可以从永诺官网下载或通过彩盒二维码扫描直接下载。以下是APP控制页面说明:

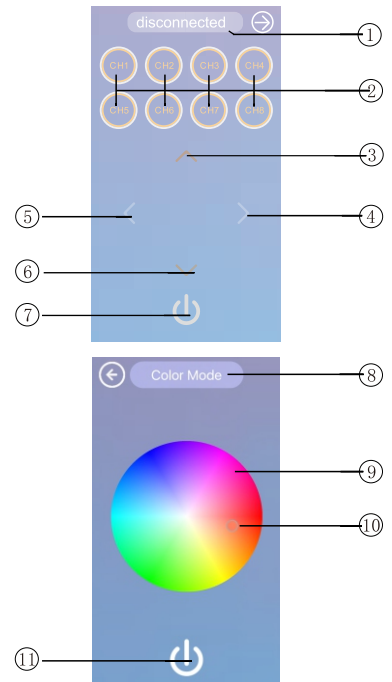

- 1、蓝牙连接与蓝牙断开选择。
- 2、频道共有8个选择。
注:YN360选择任意频道都可控制,此APP兼容永诺LED无线控制系统。
- 3、3200K色温亮度加键,向上滑动进行调节。
- 4、5500K色温亮度加键,向右滑动进行调节。
- 5、5500K色温亮度减键,向左滑动进行调节。
- 6、3200K色温亮度减键,向下滑动进行调节。
- 7、摄像灯开关控制键。
- 8、彩色模式,通过向右滑动手机屏幕顶端标志“⊕”进行切换。
- 9、RGB颜色板。
- 10、RGB颜色拾取控件。
- 11、摄像灯开关控制键。

七、故障分析及排除

在使用过程中,您可能遇到以下问题:

故障	原因	处理方法
打开电源开关完全无反应	电池电量不足 电路板损坏	使用新电池或外接电源使用 返厂维修
亮度不足,调至最亮仍然很暗	电池电量不足	使用新电池或充电后使用
测试电量不准确,调高亮度时显示低电量,调低亮度后电量又满格了	电池电量测试所指示的是:当前亮度下能使用的时间长短。调高亮度后,需要的电量更多,所使用的时间变短,故电量显示变少了	属于正常现象,无需处理
手机无法遥控摄像灯	距离太远	遥控的距离在15米内

深圳市永诺摄影器材股份有限公司
地址:深圳市福田区华强北赛格科技园2栋5楼B509室
电话:0755-8376 2448
网址: www.hkyongnuo.com
生产地址:深圳市龙华新区大浪街道大浪社区华宁西路东龙兴科技园2#厂房四楼、五楼东侧
售后电话:400-0013-888

Before using this product, please read this user manual carefully and keep it properly for reference.

Overview

First of all, thank you for using the YN360 LED video light. YN360 is the first LED video light which made of full color RGB SMD lamps and LED lamp beads. It is formed by 40 RGB SMD lamps, 160 LED lamp beads with 3200K color temperature and 160 LED lamp beads with 5500K color temperature. The RGB SMD lamps can provide red, green, blue mode which with more rich color type, the RGB SMD lamps color can be controlled by the mobile phone. The color temperature of YN360 can be adjusted from 3200-5500K as needed; adopts the Yongnuo proprietary LED driving technology and encoder digital dimming mode, thus the video light can be dimmed accurately and reliable; mobile phone wirelessly remote control the power of LED light. With the advantages of simple operation, practical use and color diversity.

I. Product Structure

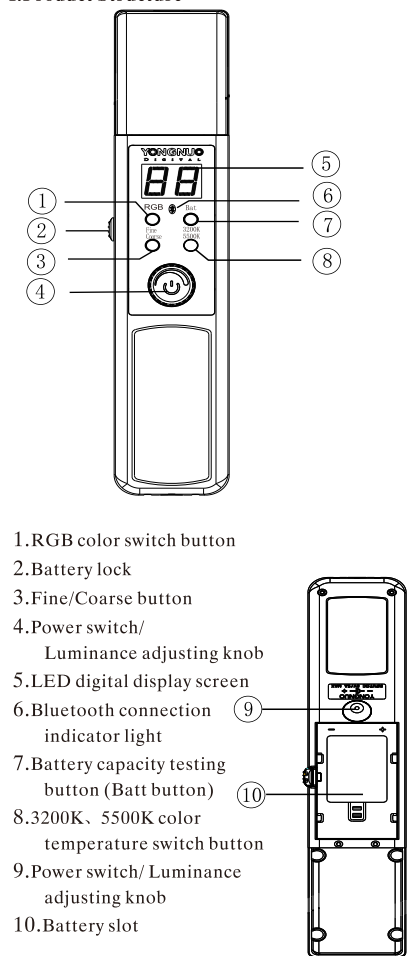

1. RGB color switch button
2. Battery lock
3. Fine/Coarse button
4. Power switch/
Luminance adjusting knob
5. LED digital display screen
6. Bluetooth connection
indicator light
7. Battery capacity testing
button (Batt button)
8. 3200K、5500K color
temperature switch button
9. Power switch/ Luminance
adjusting knob
10. Battery slot

II. Function Introduction

1. The first RGB full color camera lights in this industry which can make your creation with more features.
2. The main light adopts 160 LED lamp beads with 3200K color temperature and other 160 LED lamp beads with 5500K color temperature extra-large luminous chips, the high display index lamp beads makes the color restore truly and naturally.
3. YN360 adopts YONGNUO proprietary LED driving technology which does great help to avoid corrugation and stroboscopic flash effectively.
4. YN360 adopts encoder digital dimming system, including coarse tuning mode and fine tuning mode.
5. On the LED digital display screen of YN360, the parameter of the power output is intuitional.
6. Shooting for long time is possible because YN360 supports external DC power input (power adapter is optional).
7. The color temperature plate adopts magnet technology that will be more convenient.

III. Method of Application

1. Battery Installation
 - a. When the lithium battery is mounted, the battery should be mounted to the card groove according to the arrow direction.
Note: It is recommended to use Yongnuo NP-F750 battery to get more durable shooting time. The maximum capacity of the battery is 5200mAh. In the highest brightness, it can be used for about 120 minutes. please remove the battery when not in use.

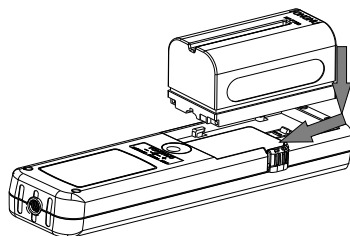

- b. When removing the lithium batteries, please press the battery lock and then take out the lithium batteries.

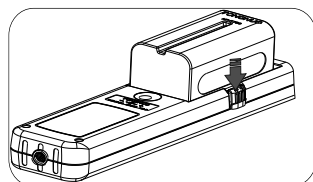

2. Fasten video light as follow as needed:
Fasten the video light to the tripod directly

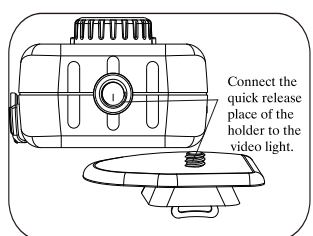
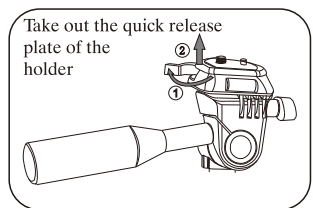

Fasten the video light to the tripod

3. Start up & Shut down and Brightness adjustment

Press the power switch, the LED camera light enabled, rightwards rotate to increase the brightness, or leftwards rotate to reduce the brightness.

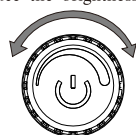

Brightness is adjusted by left and right rotation

4. RGB color switch button

Press the button when the red light on, the luminance of red light can be adjusted; when the green light on, the luminance of green light can be adjusted; and when the blue light on, the luminance of blue light can be adjusted. It can acquire different color by changing the luminance ratio of the three colors. Note: the RGB color mode and the 3200K、5500K color temperature mode can not be used at the same time.

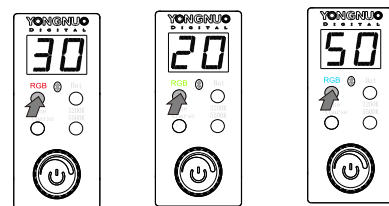

Red mode Green mode Blue mode

5. Fine/Coarse button

Equipped with coarse and fine adjusting mode, which will be more convenient for using. Press the Coarse/Fine button to conduct to Coarse/Fine adjustment, when the indicator light of Coarse bright, it will enter into coarse adjusting mode, the luminance will be adjusted with 10% as an adjusting grade. Then press the button to switch to fine adjusting, the luminance will be adjusted with 1% as an adjusting grade.

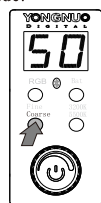

Coarse tuning mode

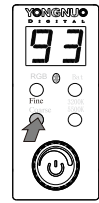

Fine tuning mode

6. Battery capacity testing button (Batt button)

Press the electric quantity testing button for electric test, when the Batt function indicator light on, the reading of LED display shown is the battery capacity. The readings can be divided into P0-P9 which indicates 0%-90% of the electric quantity. The readings as the picture shown indicates the electric quantity is 30%. (Note: the rest electric quantity of test when the brightness is low is different from that of the test when the brightness is high, the service life is tested under the current brightness).

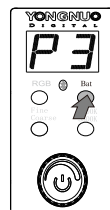

The digital tube display is the battery electricity quantity

7. 3200K、5500K color temperature switch button

It can get the color temperature between 3200K to 5500K by changing the luminance ratio of the two color temperature. Note: the RGB color mode and the 3200K、5500K color temperature mode can not be used at the same time.



press the button the indicator light bright on the 3200K, rotate the brightness adjustment knob to adjust the light of 3200K color temperature

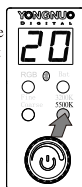

press the button the indicator light bright on the 5500K, rotate the brightness adjustment knob to adjust the light of 5500K color temperature

8. External Power Supply

It is recommended to use YONGNUO power adapter with YN360 to obtain lasting service time. When using external power supply, the video light will stop the battery power supply automatically and will not get the battery charged. The external power supply interface outside is positive and the interface inside is negative. The input voltage is 8V and the electric current is 5A. Note: If YN360 defective when it is used with power adapter of other brands, YN360 will no longer be guaranteed for repair.

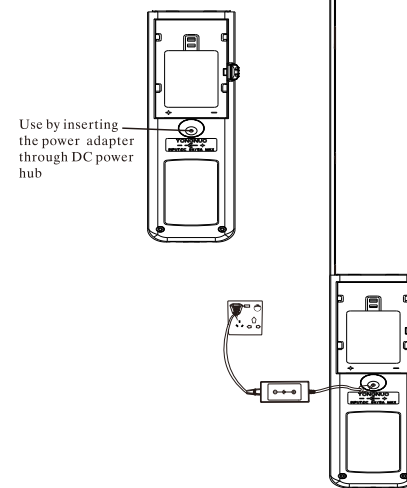

Use by inserting the power adapter through DC power hub

IV. Color Temperature Filters

The product is attached with one piece of color temperature plate. Take out the color temperature plate behind the product, replace it and it can be used by putting in front of the lamp shell and absorbed by the magnet.

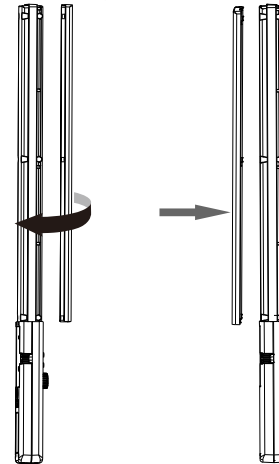

V. Product Specification

Light Source	320 LED lamp beads and 40 RGB SMD lamps		
Color Temperature	3200K、5500K and RGB full color		
Color Rendering Index	≥95	Control distance	<15M
Output power	19.2W	Mobile control	Bluetooth 4.0
Lumen	2480LM	Average Service Life	50000H
Weight	489G	Luminance Angle	55° and 110°
Compatible batteries	One NP-F series lithium batteries		
External power source	8V 5A DC power supply		
Size	583*48*24mm		
Contents	Video light (1)、User Manual (1)、CT Filters (1)、Storage Bag(1) Note: Please contact your dealer if anything missing.		

VI. Mobile APP Remote Control

The product supports mobile remote control (supports Android 4.3 or above blue tooth carried 4.0 smartphone/ IOS7.0 and iPhone4S or above version phone), the APP can be downloaded from the YONGNUO official website or download through scanning the two-dimension code on the gift box.

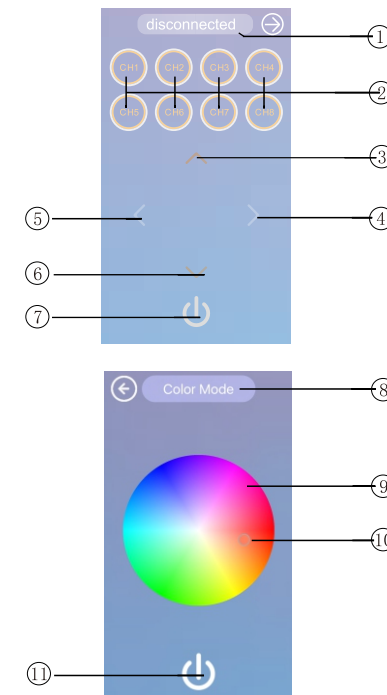

The APP Control Page Specification

1. Bluetooth connection and disconnection option
2. Total 8 channels.
Note: You can select any channel to remote control YN360 and the APP is compatible with the LED wireless system.
3. 3200 color temperature luminance increased button, slide upward to adjust.
4. 5500 color temperature luminance increased button, slide towards the right to adjust.
5. 5500 color temperature luminance decreased button, slide towards the left to adjust.
6. 3200 color temperature luminance increased button, slide downward to adjust.
7. Video light switch button
8. Color pattern, switch by sliding towards to the right of the top mark "⊕" on the phone screen.
9. RGB color plate
10. RGB color picker control
11. Video light switch button

VII. Failure Analysis and Troubleshooting

When using this product, you may encounter the following problems

Description	Cause	Troubleshooting
No reaction after power on	Low Battery	Install new batteries or connect external power supply
	Damaged circuit board	Depot repair
Inadequate or low luminance at the greatest luminous intensity	Low battery	Install new batteries or re-charge the batteries
Inaccurate battery capacity test: low luminance and full battery in low luminance.	The battery capacity indicates the length of time available for the use in the current luminance. Higher luminance required more power and the length of time available for use will be shortened, so the battery capacity shown gets lower	Normal phenomenon and no measure needed
The mobile phone could not remote control the video light	Too far away	The remote control distance is within 15 meters

SHENZHEN YONGNUO PHOTOGRAPHY EQUIPMENT Co., Ltd.

Add: 2-B509 Saige Science & Technology Park, North Huaqiang Rd, Futian District, Shenzhen, China

TEL: 0755-8376 2448

Web: www.hkyongnuo.com

Manufacture address: 4/F, East Building 2, Donglongxing Technology Park, East Huaning Road, Dalang Street, Longhua District, Shenzhen

After-sales Service TEL: 400-0013-888